



Fastening- and protection material



Hydynamic Holland BV, Marssteden 28, 7547 TC ENSCHEDE, the Netherlands
Telefoon: +31(0)53-4282048, info@hydynamic.nl, www.hydynamic.nl

Fastening- and protection material

Corrugated protective conduit

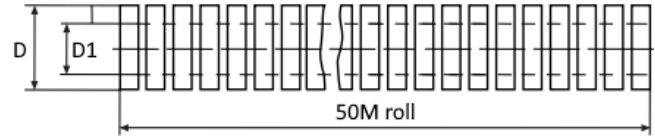

Item number	\varnothing	D1	Material
0121-0010-0007	9,9	6,9	Polypropylene
0121-0010-0010	12,9	10,1	Polypropylene

PP (polypropylene)

50m rolls

This protective hoses are available in several designs, is the desired one not listed? Please contact us for the possibilities.

Fastening- and protection material

HOSE CLAMP TWO SIDED (DIN72573)

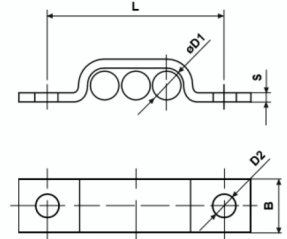
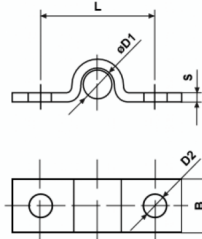

Partnr	Nr / Hose mm	d1	d2	L	B	S	Material
1114-0000-0401	1 x 4 mm	4	4.8	17	10	1	Galvanised
1114-0000-0402	2 x 4 mm	4	4.8	21	10	1	Galvanised
1114-0000-0404	4 x 4 mm	4	4.8	32	10	1	Galvanised
1114-0000-0406	6 x 4 mm	4	4.8	40	10	1	Galvanised
1114-0000-0601	1 x 6 mm	6	4.8	20	10	1	Galvanised
1114-0000-0602	2 x 6 mm	6	4.8	26	10	1	Galvanised
1114-0000-0603	3 x 6 mm	6	4.8	33	10	1	Galvanised
1114-0000-0604	4 x 6 mm	6	4.8	39	10	1	Galvanised
1114-0000-0605	5 x 6 mm	6	4.8	45	10	1	Galvanised
1114-0000-0606	6 x 6 mm	6	4.8	52	10	1	Galvanised
1114-0000-0801	1 x 8 mm	8	4.8	22	10	1	Galvanised
1114-0000-0802	2 x 8 mm	8	4.8	30	10	1	Galvanised
1114-0000-0803	3 x 8 mm	8	4.8	39	10	1	Galvanised
1114-0000-0804	4 x 8 mm	8	4.8	47	10	1	Galvanised
1114-0000-0805	5 x 8 mm	8	4.8	56	10	1	Galvanised
1114-2000-0601	1 x 6 mm	6	4.8	20	10	1	Stainless steel 316TI
1114-2000-0602	2 x 6 mm	6	4.8	26	10	1	Stainless steel 316TI
1114-2000-0603	3 x 6 mm	6	4.8	33	10	1	Stainless steel 316TI
1114-2000-0604	4 x 6 mm	6	4.8	39	10	1	Stainless steel 316TI
1114-2000-0605	5 x 6 mm	6	4.8	45	10	1	Stainless steel 316TI
1114-2000-0606	6 x 6 mm	6	4.8	52	10	1	Stainless steel 316TI
1114-2000-0801	1 x 8 mm	8	4.8	22	10	1	Stainless steel 316TI

Partnr	Nr / Hose mm	d1	d2	L	B	S	Material
1114-2000-0802	2 x 8 mm	8	4.8	30	10	1	Stainless steel 316TI
1114-2000-0803	3 x 8 mm	8	4.8	39	10	1	Stainless steel 316TI
1114-2000-0804	4 x 8 mm	8	4.8	47	10	1	Stainless steel 316TI

Two-sided pipe clamp, for attaching one to six hoses.

Fastening- and protection material

HOSE CLAMP ONE SIDED (DIN72571)

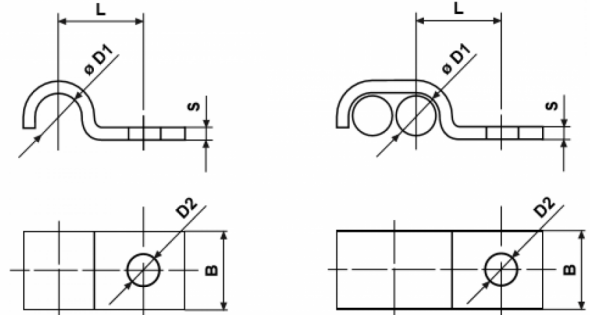

Partnr	Nr / Hose mm	d1	d2	L	B	S	Material
1110-0000-0401	1 x 4 mm	4	4.8	9	10	1	Galvanised
1110-0000-0402	2 x 4 mm	4	4.8	10	10	1	Galvanised
1110-0000-0601	1 x 6 mm	6	4.8	10	10	1	Galvanised
1110-0000-0602	2 x 6 mm	6	4.8	13	10	1	Galvanised
1110-0000-0701	1 x 7 mm	7	4.8	10	10	1	Galvanised
1110-0000-0801	1 x 8 mm	8	4.8	11	10	1	Galvanised
1110-0000-0802	2 x 8 mm	8	4.8	15	10	1	Galvanised
1110-0000-1001	1 x 10 mm	10	4.8	11	10	1	Galvanised
1110-0000-1201	1 x 12 mm	12	5.8	16	12	1.5	Galvanised
1110-2000-0401	1 x 4 mm	4	4.8	9	10	1	Stainless steel 316TI
1110-2000-0801	1 x 8 mm	8	4.8	11	10	1	Stainless steel 316TI
1110-2000-1001	1 x 10 mm	10	4.8	11	10	1	Stainless steel 316TI

Fastening- and protection material

HOSE CLAMP (RSGU)

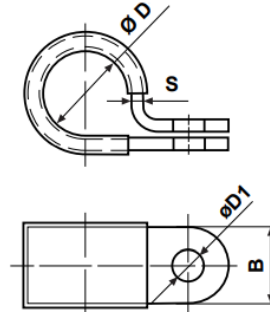

Partnr	D	D1	B	S	Material
1105-0000-0412	4	5,3	12	0,5	Galvanised
1105-0000-0612	6	5,3	12	0,5	Galvanised
1105-0000-0812	8	5,3	12	0,5	Galvanised
1105-0000-1012	10	5,3	12	0,5	Galvanised
1105-0000-1212	12	5,3	12	0,5	Galvanised
1105-0000-1512	15	5,3	12	0,5	Galvanised
1105-0000-2012	20	5,3	12	0,5	Galvanised
1105-0000-2212	22	5,3	12	0,5	Galvanised
1105-0000-2512	25	5,3	12	0,5	Galvanised
1105-0000-0615	6	6,4	15	0,6	Galvanised
1105-0000-0815	8	6,4	15	0,6	Galvanised
1105-0000-1015	10	6,4	15	0,6	Galvanised
1105-0000-1215	12	6,4	15	0,6	Galvanised
1105-0000-1315	13	6,4	15	0,6	Galvanised
1105-0000-1515	15	6,4	15	0,6	Galvanised
1105-0000-1615	16	6,4	15	0,6	Galvanised
1105-0000-1815	18	6,4	15	0,6	Galvanised
1105-0000-2015	20	6,4	15	0,6	Galvanised
1105-0000-2215	22	6,4	15	0,6	Galvanised
1105-0000-2515	25	6,4	15	0,6	Galvanised
1105-0000-0820	8	8,4	20	0,8	Galvanised
1105-0000-1220	12	8,4	20	0,8	Galvanised

Partnr	D	D1	B	S	Material
1105-0000-1520	15	8,4	20	0,8	Galvanised
1105-0000-1820	18	8,4	20	0,8	Galvanised
1105-0000-2020	20	8,4	15	0,6	Galvanised
1105-0000-2220	22	8,4	20	0,8	Galvanised
1105-0000-2520	25	8,4	20	0,8	Galvanised
1105-0000-3020	30	8,4	20	0,8	Galvanised
1105-0000-3520	35	8,4	20	0,8	Galvanised
1105-0000-5020	50	8,4	20	1	Galvanised
1105-0000-3825	38	10,5	25	1	Galvanised
1105-0000-5025	50	10,5	25	1	Galvanised
1105-0000-7525	75	10,5	25	1,25	Galvanised
1105-2000-0412	4	5,3	12	0,5	Stainless steel 316TI
1105-2000-0612	6	5,3	12	0,5	Stainless steel 316TI
1105-2000-0812	8	5,3	12	0,5	Stainless steel 316TI
1105-2000-1012	10	5,3	12	0,5	Stainless steel 316TI
1105-2000-1812	18	5,3	12	0,5	Stainless steel 316TI
1105-2000-2212	22	5,3	12	0,5	Stainless steel 316TI
1105-2000-0615	6	6,4	15	0,6	Stainless steel 316TI
1105-2000-0815	8	6,4	15	0,6	Stainless steel 316TI
1105-2000-1015	10	6,4	15	0,6	Stainless steel 316TI
1105-2000-1215	12	6,4	15	0,6	Stainless steel 316TI
1105-2000-1515	15	6,4	15	0,6	Stainless steel 316TI
1105-2000-1815	18	6,4	15	0,6	Stainless steel 316TI
1105-2000-2515	25	6,4	15	0,6	Stainless steel 316TI
1105-2000-1520	15	8,4	20	0,8	Stainless steel 316TI
1105-2000-1820	18	8,4	20	0,8	Stainless steel 316TI
1105-2000-3220	32	8,4	20	0,8	Stainless steel 316TI
1105-2000-3820	38	8,4	20	0,8	Stainless steel 316TI

Fastening- and protection material

CABLE TIES

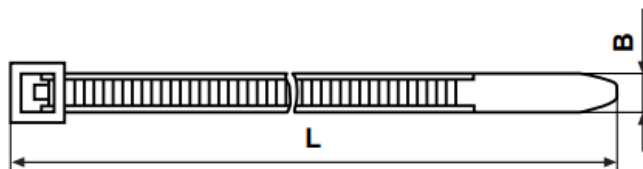

Partnr	Ø	L	Verpakkingseenheid
1108-0025-0140	2,5	140	100
1108-0048-0200	4,8	200	100
1108-0048-0380	4,8	380	100
1108-0076-0368	7,5	360	100
1108-0090-0780	9	780	100

Polyamide 6.6

Fastening- and protection material

PROTECTIVE SPRINGS

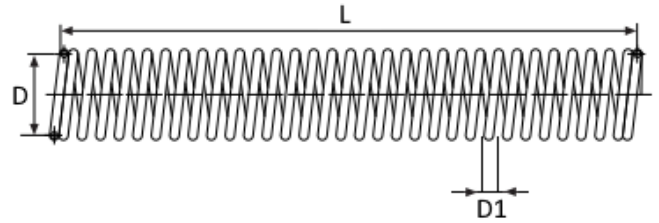

◇	◇1	◇
10	1,3	5M
16	2	5M
19	2	5M

Fastening- and protection material

SPIRAL HOSE PROTECTOR

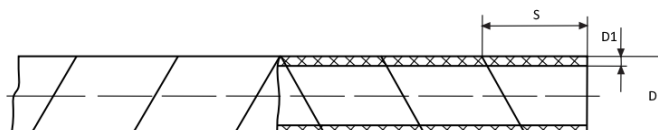

Partnr

∅

D1

S

0121-0001-0006

6

0,75

7

0121-0001-0012

12

1,5

14

PE (polyethylene)

